

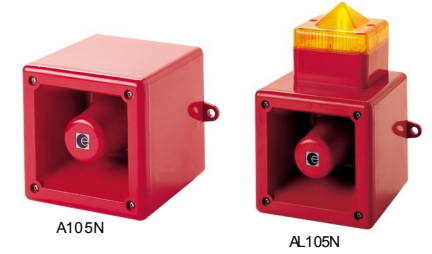

A105N - 32 Tone 'AlertAlarm'



A105N

AL105N

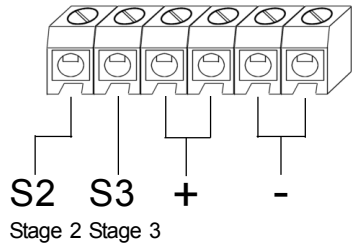

24, 48vdc

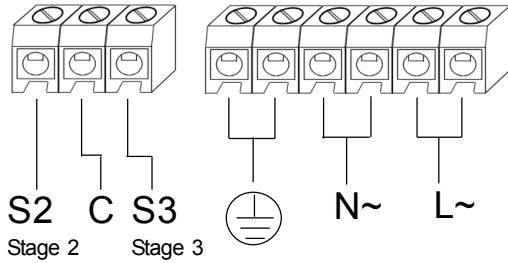
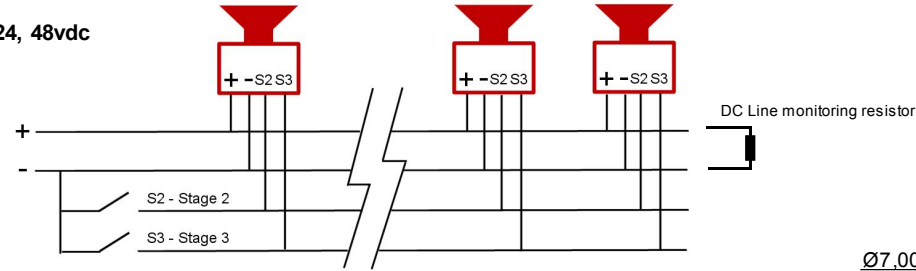

115, 230vac

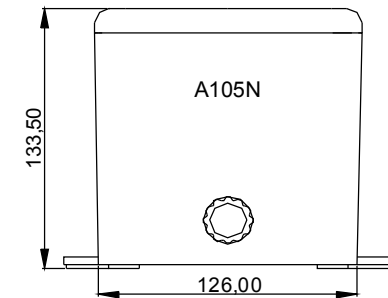
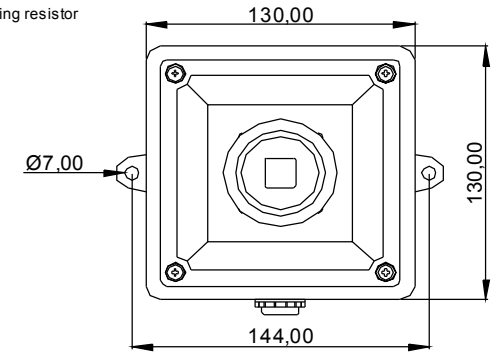
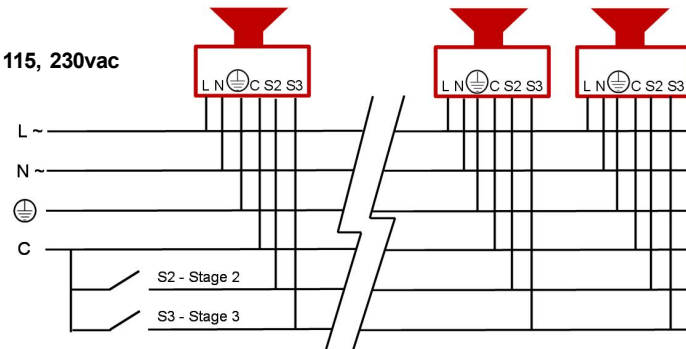

Voltage :	24vdc	48vdc	115vac	230vac	24vac
			50/60Hz	50/60Hz	50/60Hz
Voltage range :	10-30vdc	35-60vdc	+/-10%	+/-10%	+/-10%
Current mA :	25mA	50mA	20mA	15mA	40mA



- Volume Control
- Réglage du volume
- Steuerung der Lautstärke
- Controllo volume
- Controlo do Volume
- Control Volumen
- Volumen kontrol
- Volumeregeling
- Volum kontroll
- Völym kontroll



- Tone Selection
- Sélection de la tonalité
- Tonwahl
- Selezione tono
- Seleção de tons
- Selección Tono
- Valg af tone
- Toonselectie
- Velge tone
- Tonval

A105N 24vdc (18-30vdc) & 48vdc (35-60vdc) units are CPD Compliant.

EN54-3 Type B IP55

Stage 1
tone **Frequency**
 Description

Tone 2	800/1000Hz @ 0.25 sec Alternating
Tone 3	500/1200Hz @ 0.3Hz 0.5 sec Slow Whoop
Tone 9	1200/500Hz @ 1Hz - DIN / PFEER P.T.A.P.
Tone 15	800Hz Continuous
Tone 16	660Hz 150ms ON 150ms OFF
Tone 17	544Hz (100mS)/440Hz (400mS) - NF S 32-001

The tones listed have been tested to EN54-3 and are compliant with the Construction Product Directive 89/106/EEC.

EN54-3 test data: document D2273

Stage 1	Frequency Description.	A105N dB@ 1m	Switch						Stage 2 (S2)	Stage 3 (S3)
			1	2	3	4	5	6		
Tone 1	340 Hz Continuous	102dB(A) @1m							Tone 2	Tone 5
Tone 2	800/1000Hz @ 0.25 sec Alternating	106dB(A) @1m							Tone 17	Tone 5
Tone 3	500/1200Hz @ 0.3Hz 0.5 sec Slow Whoop	106dB(A) @ 1m							Tone 2	Tone 5
Tone 4	800/1000Hz @ 1Hz Sweeping	106dB(A) @ 1m							Tone 6	Tone 5
Tone 5	2400Hz Continuous	112dB(A) @1m							Tone 3	Tone 20
Tone 6	2400/2900Hz @ 7Hz Sweeping	108dB(A) @1m							Tone 7	Tone 5
Tone 7	2400/2900Hz @ 1Hz Sweeping	108dB(A) @1m							Tone 10	Tone 5
Tone 8	500/1200/500Hz @ 0.3Hz Sweeping	106dB(A) @ 1m							Tone 2	Tone 5
Tone 9	1200/500Hz @ 1Hz - DIN / PFEER P.T.A.P.	106dB(A) @ 1m							Tone 15	Tone 2
Tone 10	2400/2900Hz @ 2Hz Alternating	110dB(A) @1m							Tone 7	Tone 5
Tone 11	1000Hz @ 1Hz Intermittent	106dB(A) @ 1m							Tone 2	Tone 5
Tone 12	800/1000Hz @ 0.875Hz Alternating	106dB(A) @ 1m							Tone 4	Tone 5
Tone 13	2400Hz @ 1Hz Intermittent	112dB(A) @1m							Tone 15	Tone 5
Tone 14	800Hz 0.25sec on, 1 sec off Intermittent	108dB(A) @1m							Tone 4	Tone 5
Tone 15	800Hz Continuous	108dB(A) @1m							Tone 2	Tone 5
Tone 16	660Hz 150mS on, 150mS off Intermittent	104dB(A) @1m							Tone 18	Tone 5
Tone 17	544Hz (100mS)/440Hz (400mS) - NF S 32-001	104dB(A) @1m							Tone 2	Tone 27
Tone 18	660Hz 1.8sec on, 1.8sec off Intermittent	104dB(A) @1m							Tone 2	Tone 5
Tone 19	1.4KHz-1.6KHz 1s, 1.6KHz-1.4KHz 0.5s -NFC48-265	106dB(A) @ 1m							Tone 2	Tone 5
Tone 20	660Hz Continuous	104dB(A) @1m							Tone 2	Tone 5
Tone 21	554Hz/440Hz @ 1Hz Alternating	104dB(A) @1m							Tone 2	Tone 5
Tone 22	544Hz @ 0.875 sec. Intermittent	104dB(A) @1m							Tone 2	Tone 5
Tone 23	800Hz @ 2Hz Intermittent	108dB(A) @1m							Tone 6	Tone 5
Tone 24	800/1000Hz @ 50Hz Sweeping	108dB(A) @1m							Tone 29	Tone 5
Tone 25	2400/2900Hz @ 50Hz Sweeping	108dB(A) @1m							Tone 29	Tone 5
Tone 26	Bell	100dB(A) @1m							Tone 2	Tone 15
Tone 27	554Hz Continuous	104dB(A) @1m							Tone 26	Tone 5
Tone 28	440Hz Continuous	103dB(A) @1m							Tone 2	Tone 5
Tone 29	800/1000Hz @ 7Hz Sweeping	105dB(A) @1m							Tone 7	Tone 5
Tone 30	300Hz Continuous	100dB(A) @1m							Tone 2	Tone 5
Tone 31	660/1200Hz @ 1Hz Sweeping	105dB(A) @1m							Tone 26	Tone 5
Tone 32	Two tone chime.	103dB(A) @1m							Tone 26	Tone 15

NOTE: Please check factory settings and ensure the correct alarm tone is selected for your country or application.

Pas op: bij ingebruikstelling dient u zich ervan te overtuigen dat de unit op de juiste toon is ingesteld.

Tone Selection / switch setting.

- Switch settings are shown in the tone table. Black squares are the switch levers in the ON position.
- Les réglages des commutateurs sont indiqués sur le tableau de tonalités. Les carrés noirs représentent les leviers des commutateurs en position MARCHE (ON).
- Die Schaltereinstellungen sind in der Tabelle der Töne angegeben. Die schwarzen Quadrate kennzeichnen die Ein-Positionen der Schalter.
- Le impostazioni degli interruttori sono mostrate nella tabella dei segnali acustici. I riquadri neri indicano le leve degli interruttori nella posizione ON.
- Los ajustes de interruptor se muestran en la tabla de tonos. Los cuadros negros representan las palancas de los interruptores en la posición ON.
- Os ajustes dos interruptores estão indicados na tabela de sons. Os quadrados pretos indicam que as alavancas dos interruptores estão na posição LIGADA.
- Kontaktilinställningarna framgår av toneskemaet. Et sort felt betyder, at kontakten er aktiv ("ON").
- De schakelinstellingen staan vermeld in de toontabel. Zwarte vierkanten zijn de schakelaars in de stand AAN.
- Bryterinnstillingen er beskrevet i tonetabellen. De svarte firkantene indikerer bryterposisjonene i PÅ-posisjon.
- Brytarinställningarna visas i signaltabellen. De svarta fyrkanterna är brytarna i ON-läge.

ISN2201-B

No liability is accepted for any consequence of the use of this document. The technical specification of this unit is subject to change without notice due to our policy of continual product development. All dimensions are approximate. This unit is sold subject to our standard conditions of sale, a copy of which is available on request.

- Reverse polarity switching - On DC versions the second stage alarm tone can be selected by reversing the polarity of the supply voltage if switch 6 is in the ON position and link L1 is made.
- Comutation de polarité inversée. - Dans le cas des appareils c.c., il est possible de sélectionner la tonalité d'alarme de deuxième étage en inversant la tension d'alimentation si la paire de broches L1 de la carte de circuits imprimés est reliée par un cavalier.
- Schalten durch Polaritätsumkehrung - Bei Gleichspannungsausführungen kann der Alarmton der zweiten Stufe durch Umpolung der Versorgungsspannung gewählt werden, wenn das Stiftpaar L1 auf der Leiterplatte verbunden ist.
- Comutazione polarità inversa: sulle unità in CC, il segnale acustico di allarme di secondo livello può essere selezionato invertendo la tensione di alimentazione se il connettore con piedini L1 del circuito è collegato.
- Comutación de polaridad inversa: en unidades de CC el tono de alarma de la segunda fase puede seleccionarse invirtiendo la tensión de alimentación si el par de pines L1 de la PCB está conectado.
- Comutação de polaridade inversa. - Nas unidades de cc, é possível seleccionar o som de alarme da segunda fase invertendo a tensão de alimentação se o suporte de pinos L1 no circuito impresso estiver ligado.
- Invertering af polaritet. - På jævnstrømsenheder kan alarmtonen for anden fase vælges, ved at man vender spændingen, hvis L1 på printkortet er aktiveret.
- Omgekeerde polariteitsschakeling – op DC-apparaten kan de tweede fase alarmtoon geselecteerd worden door de toevolverspanning om te keren wanneer de twee PCB-pennen L1 op de PCB doorverbonden zijn.
- Reversert polaritet. På DC utgaver velges andre trinn alarmtone ved å snu tilførselsspenningen hvis hovedpinne L1 på kretskortet er linket.
- Polaritetsändring. – På DC-enheter kan en andrasteigssignal väljas genom att vända riktning på strömmen om stiftsockeln L1 på kretskortet är överbygglad.

DC Line monitoring

- Remove link L1 for line monitoring (DC).
- Couper L1 en cas de contrôle des lignes d'alimentation (c.c.).
- L1 zur Überwachung der Spannungsversorgungsleitungen (Gleichspannung) durchtrennen.
- Interrompere L1 in caso di monitoraggio delle linee dell'alimentatore (CC).
- Corte L1 si está monitorizando las líneas de alimentación eléctrica (CC).
- No caso de monitorização das linhas da alimentação eléctrica (cc), corte L1.
- Afbryd L1, hvis strømforsyningslinjerne overvåges (jævnstrøm).
- Onderbreek L1 wanneer de voedingslijnen (DC) gecontroleerd worden.
- Ta ut L1 dersom strømlinjene overvåkes (DC).
- Bryt L1 vid kontroll av strömkablarna (DC).



**>105dB(A)@1m.
112dB(A) Max.**



ATTENTION

- Disconnect from power source to prevent electrical shock before installing and servicing
- Couper l'alimentation pour empêcher tout choc électrique avant d'effectuer des travaux d'installation et d'entretien.
- Vor der Installation und Wartung von der Spannungsquelle abnehmen, um elektrische Schläge zu vermeiden.
- Prima dell'installazione e della manutenzione spegnere l'alimentazione elettrica per evitare scosse elettriche.
- Desconecte la alimentación para evitar descargas eléctricas antes de la instalación y mantenimiento
- Antes de instalar o de fazer a manutenção desligue sempre da alimentação eléctrica para evitar choques eléctricos.
- Strømmen skal afbrydes ved installering og eftersyn for at undgå elektrisk stød.
- Los koppel van de elektrische voeding om elektrische schok vóór installatie en onderhoud te voorkomen.
- Før monterig eller vedlikehold, må spenningen koples fra for å unngå strømstøt.
- Bryt strömmen innan installation och underhåll för att förhindra elektriska stötar stötar.